

BH-316 Series, Rated up to 50 Amps, 115/200 VAC, 400 Hz or 28 Vdc

See Part Number Listing on Last Page

Product Facts

- 3PST NO, Double break
- Hermetically sealed
- Auxiliary contacts available
- Meets many requirements of MIL-PRF-6106

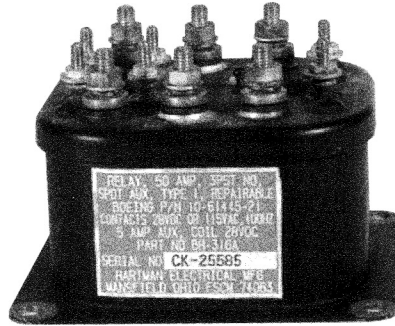

Performance Data

Electrical Characteristics

Contact Arrangement — 3PST NO, Double Break

Rated Operating Voltage — 28 Vdc or 115/200 VAC, 400 Hz, 3 phase

Resistive Rating — 50 Amps

Inductive Rating — 115/200 VAC, 400 Hz, 3 phase — 50 Amps
At 28 Vdc — 25 Amps

Motor Rating — 50 Amps

General Characteristics

Temperature Range — -55°C to +125°C

Operating Cycles (Life) at Rated Resistive Load, Min. — 100,000 cycles

Operating Cycles (Life) Mechanical, Min. — 200,000 cycles

Dielectric Strength — All Circuits to Ground — 1,500 Vrms
Circuit to Circuit — 1,500 Vrms
Coil to Ground and Aux. Contacts — 1,000 Vrms

Insulation Resistance, Initial — 100 megohm min.

Weight, Max. — 1.20 lbs

Impact Shock — 5 G

Close Time @ 28 Vdc and 25°C, Max. — 25 msec

Release Time @ 28 Vdc and 25°C, Max. — 10 msec

Coil Characteristics

Duty Cycle — Continuous

Operating Voltage, Nom. — 28 Vdc

Pickup Voltage, Max. — 18 Vdc

Dropout Voltage — 1.5 to 7 Vdc

Coil Current, Holding, Max. — 0.5 Amp

Coil Type

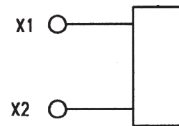

A — Continuous

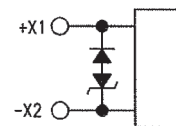

B — Continuous w/Suppression

For factory-direct application assistance, phone 419-521-9500 or fax 419-526-2749.

BH-316 Series, Rated up to 50 Amps, 115/200 VAC, 400 Hz or 28 Vdc (Continued)

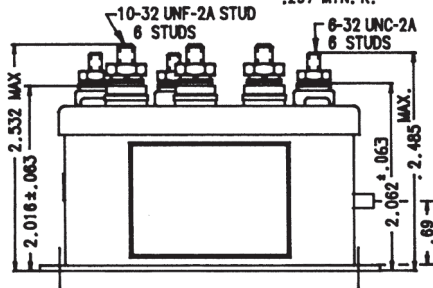
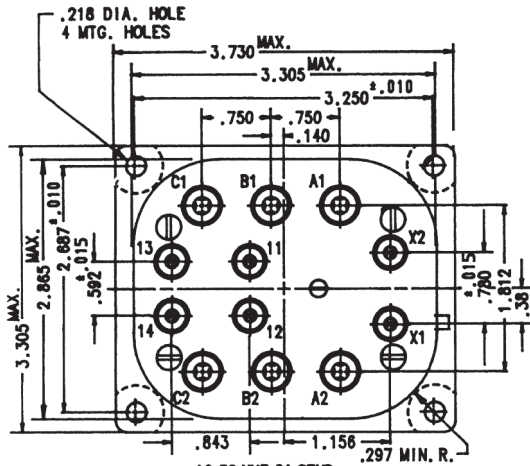

Mounting Style A

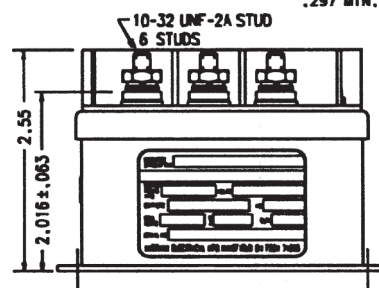
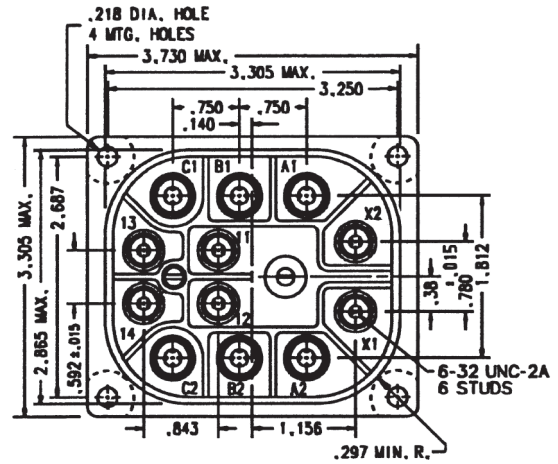

Mounting Style B

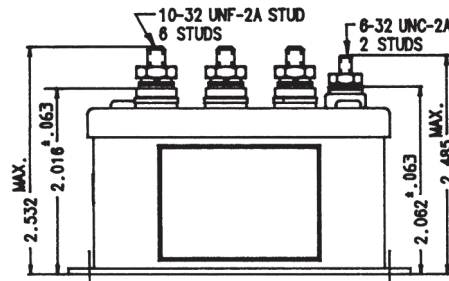
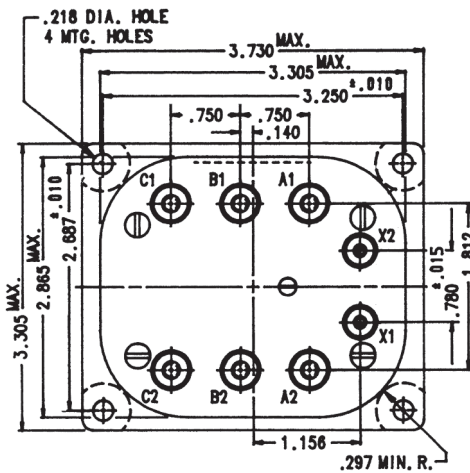

Mounting Style C

For factory-direct application assistance, phone 419-521-9500 or fax 419-526-2749.

BH-316 Series, Rated up to 50 Amps, 115/200 VAC, 400 Hz or 28 Vdc (Continued)

Circuit Configurations (Consult factory for other available circuit configurations)

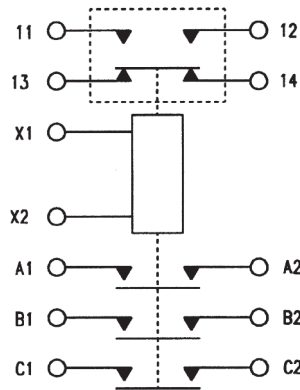

Circuit Configuration 1

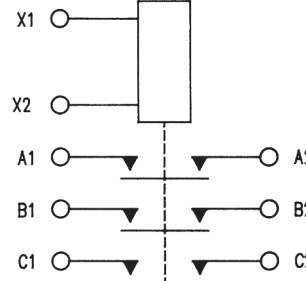

Circuit Configuration 2

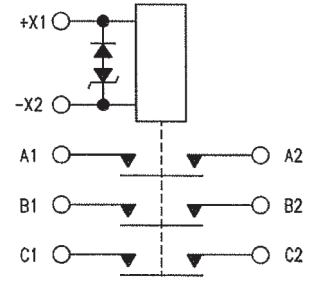

Circuit Configuration 3

HARTMAN Part Number	Construction Type	Mounting Style	Coil Type	Circuit Config.	TE Part Number
BH-316	Hermetically Sealed	A	Continuous	2	1616008-4
BH-316A	Hermetically Sealed	A	Continuous	1	1616008-5
BH-316D	Hermetically Sealed	A	Continuous	1	1616008-6
BH-316C	Hermetically Sealed	B	Continuous	3	1-1616520-0

For factory-direct application assistance, phone 419-521-9500 or fax 419-526-2749.